

VHF UHF Helical Filter Specification Sheet

Customer Name		Temwell's Part No.	TTW3489B-743M
Approval No. /dated	0906047CD	Temwell's Print Name.	3489B 743M
Work Instruction No.	200906047CD	Date	June.06.2009

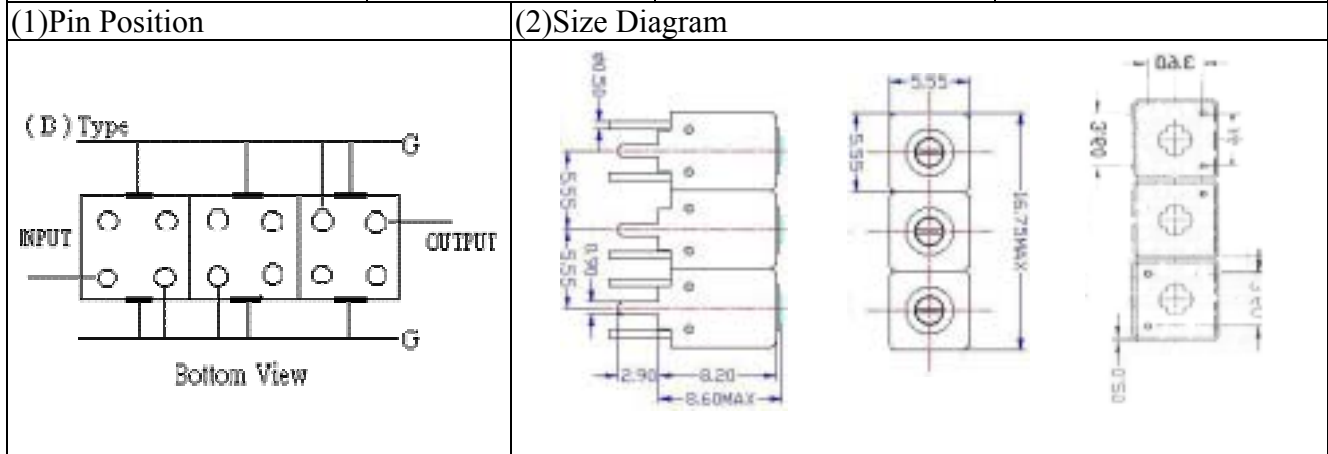

(3) Electric Character	
Item	Specify
Center Freq.(Fo) +/- 0.5 %	743 MHz
Insertion Loss	Typ. 4.5 dB
-3 dB Bandwidth	Typ. 17 MHz
Sensitivity (Attenuation)	Fo - 50 MHz Typ. 43 dBc
	Fo + 50 MHz Typ. 30 dBc
	Fo - ()MHz Typ. dBc
	Fo +()MHz Typ. dBc
Return Loss	Min. 12 dB
Ripple	< 1 dB
Impedance	In / Out : 50 Ω
(4) Torque for Tuning Screw	> 100gf cm
(5) Temperature Condition:	
Operating Temperature	0 ~ +60
Storage Temperature	-20 ~ +70
(6) Input Power	> 0.5Watt

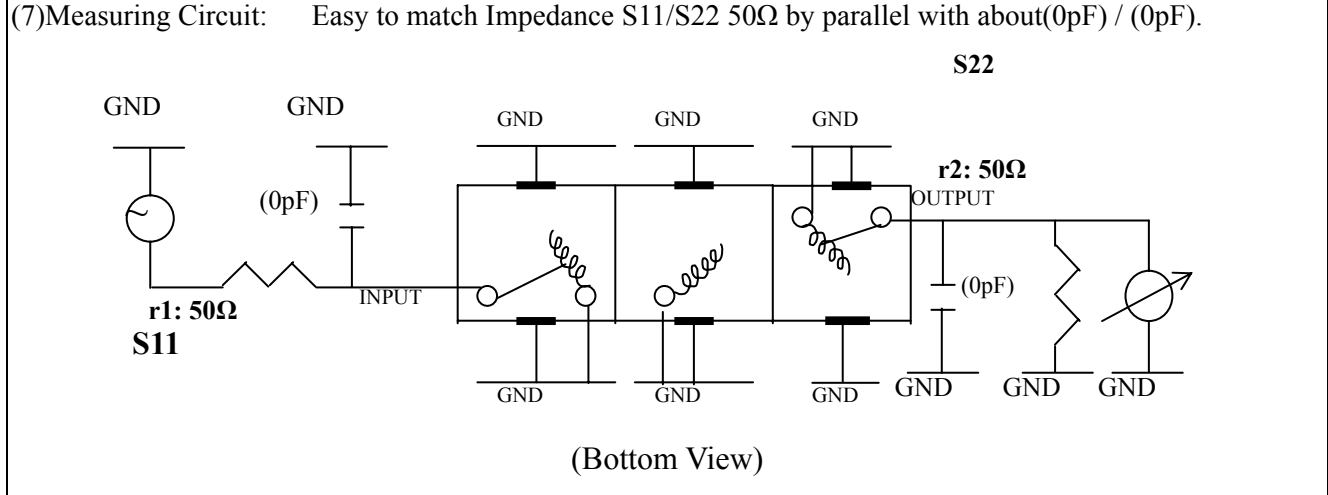

Approval C.Y.Chang	Supervisor C.K.Chang	Designer P.H.Chiang	Aperture size 5W3S(3.8*3.5) 5W046RB3.2
-----------------------	-------------------------	------------------------	--

TEMWELL CORPORATION

Performance-TTW3489B-743M

200906047CD

