

VHF UHF Helical Filter Specification Sheet

Customer Name		Temwell's Part No.	K3B-520M-10M
Approval No. /dated	20402010DC	Customer's Part No.	
Work Instruction No.	20402010DC	Date	Feb.10.2004
<input type="checkbox"/> Buyer Print name		<input type="checkbox"/> Temwell,s print name	
Case Name	7H3	Case size : (mm)	
Terminator Type	B		

* Pin Position (Pin Connection) diagram as following

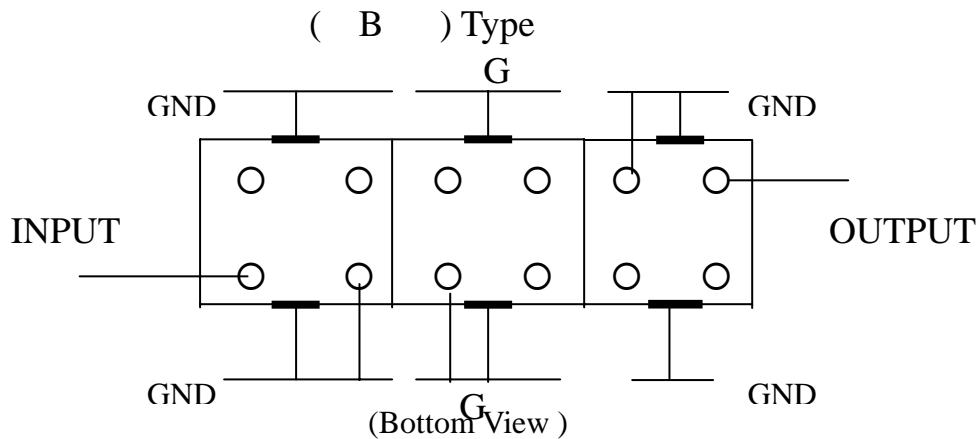

(3) Electric Character

Item	Specify
Center Freq.(Fo) +/- 0.5 %	520 MHz
Insertion Loss	Typ. 3.0 dB
-3 dB Bandwidth	Typ. 10 MHz
Sensitivity (Attenuation)	Fo -(50) MHz Typ. 41 dBc
	Fo +(50) MHz Typ. 34 dBc
	Fo -()MHz Typ. dBc
	Fo +()MHz Typ. dBc
Return Loss	Min. 12 dB
Ripple	< 1 dB
Impedance	In / Out : 50 Ω
Torque for Tuning Screw	> 60gf cm

4. Temperature Condition:

Operating Temperature	0 ~ +60
Storage Temperature	-20 ~ +70

Approval	Supervisor	Designer	Aperture size
C.Y.Chang	C.S.Chang	C.S.Chang	7H3,4*6.5(4*6.58) 7H046LB4 聚 3

TEMWELL CORPORATION

